

1

(The Stable Marriage Problem . SMP)

”



”

(matching algorithm)

- (, internet sites)
- (,)
- (internet - load balancing, 😊) /



DAVID GALE & LLOYD SHAPLEY
COLLEGE ADMISSIONS AND THE STABILITY OF MARRIAGE
THE AMERICAN MATHEMATICAL MONTHLY, VOL. 69, NO. 1 (1962)

(Matching Problem)

“

|

▪

▪

“

⋮

(matching)

"

G

, V,

, E

"

(matching):



G

1

. \Rightarrow

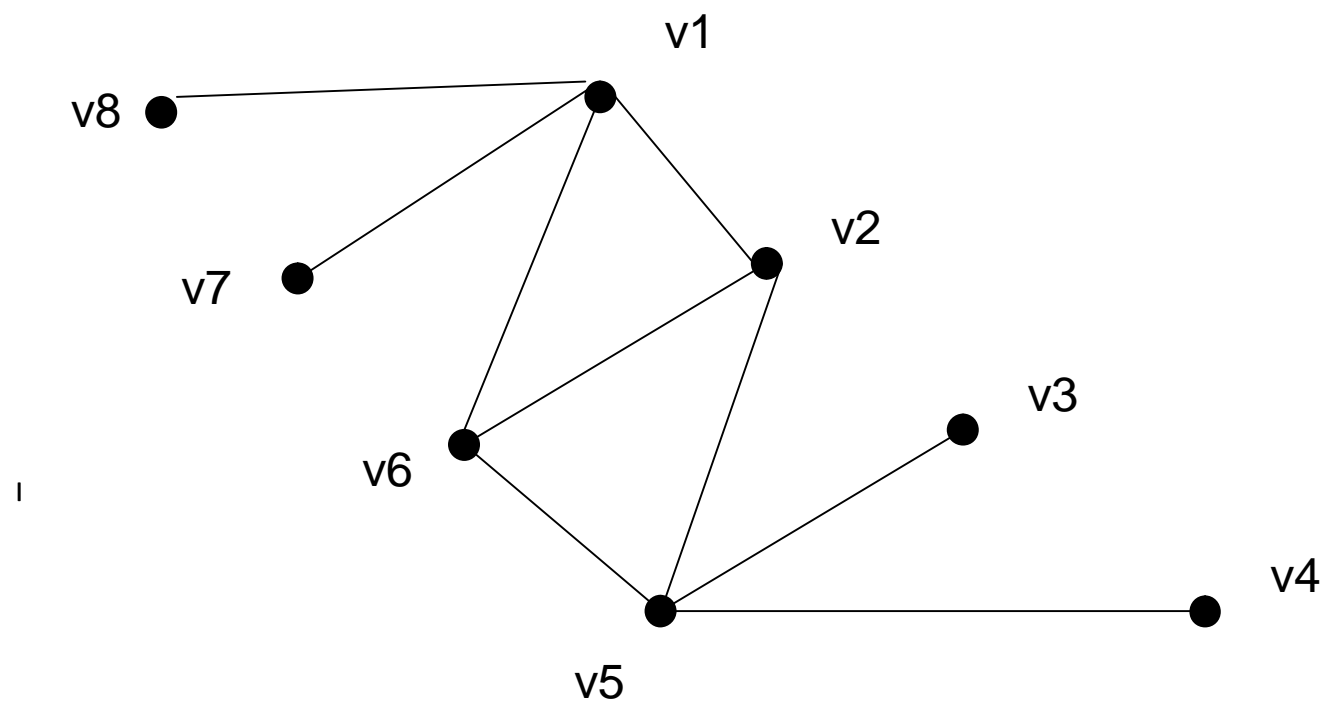

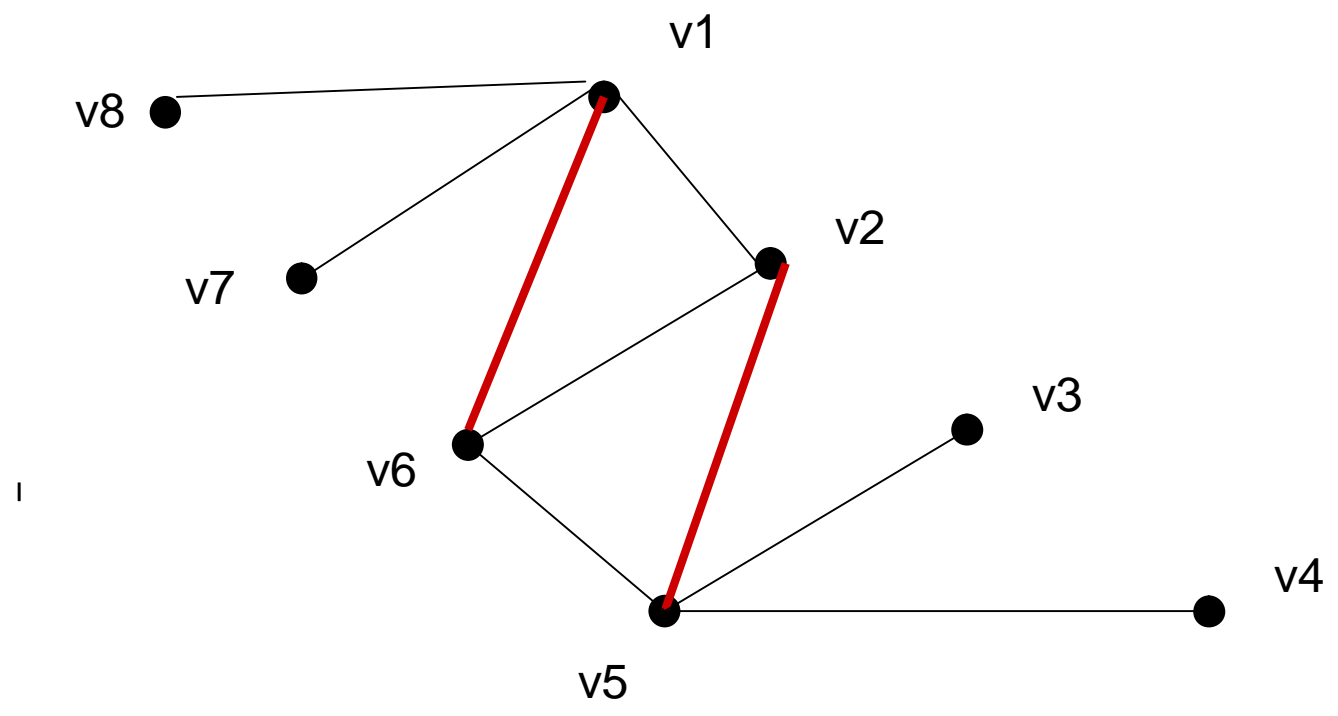

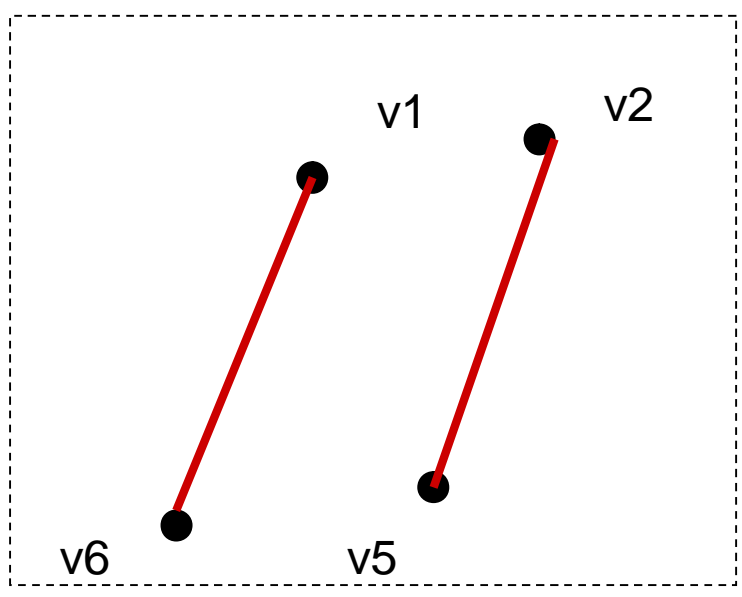
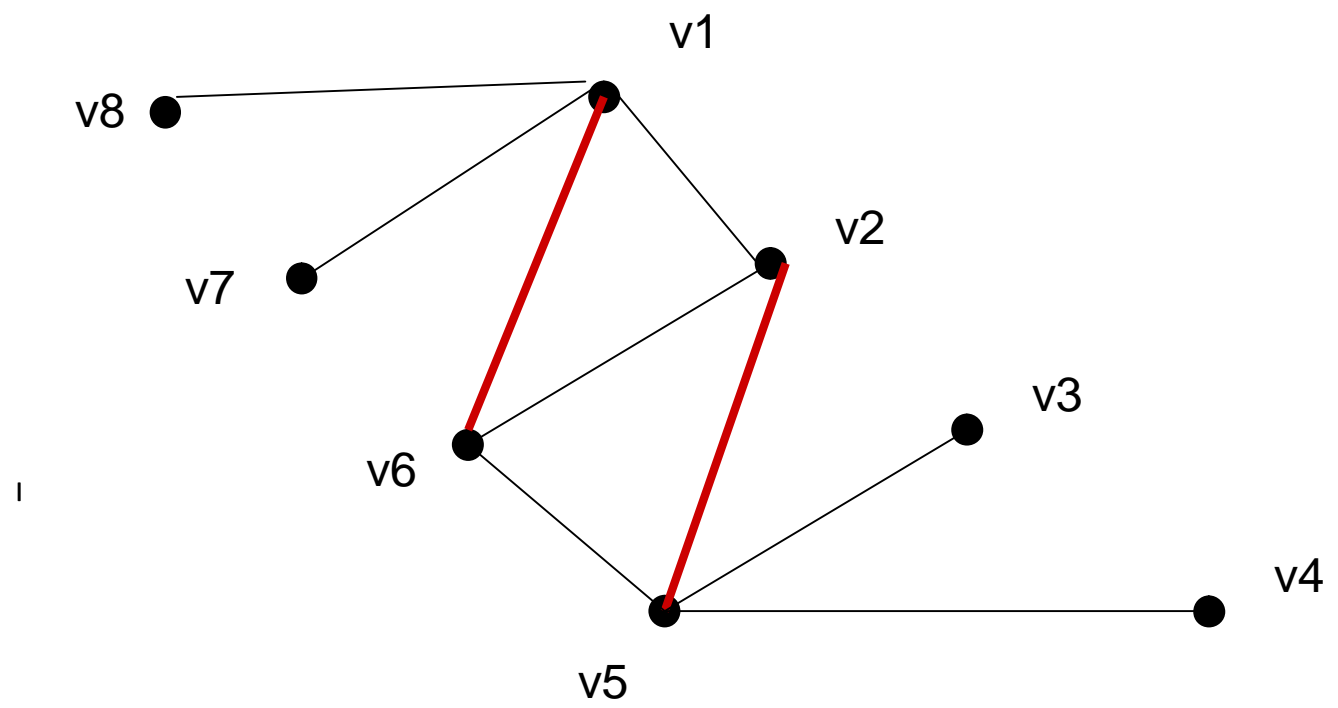

$\Leftrightarrow 2$

2

⋮

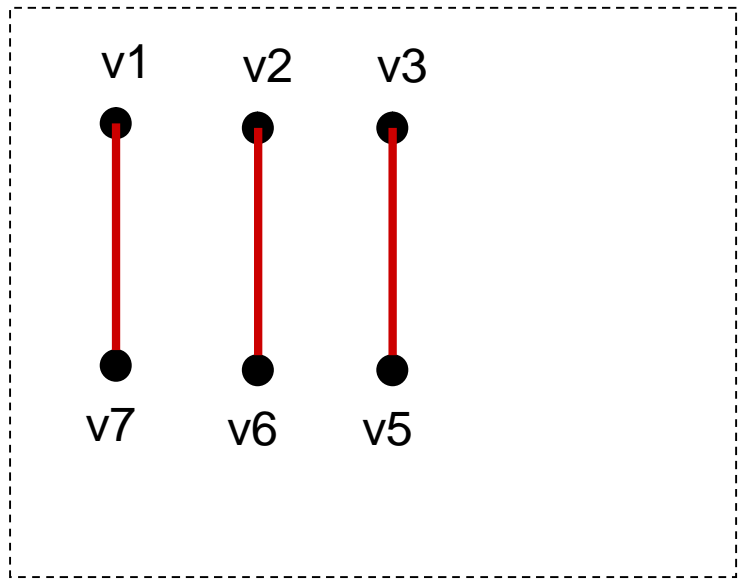
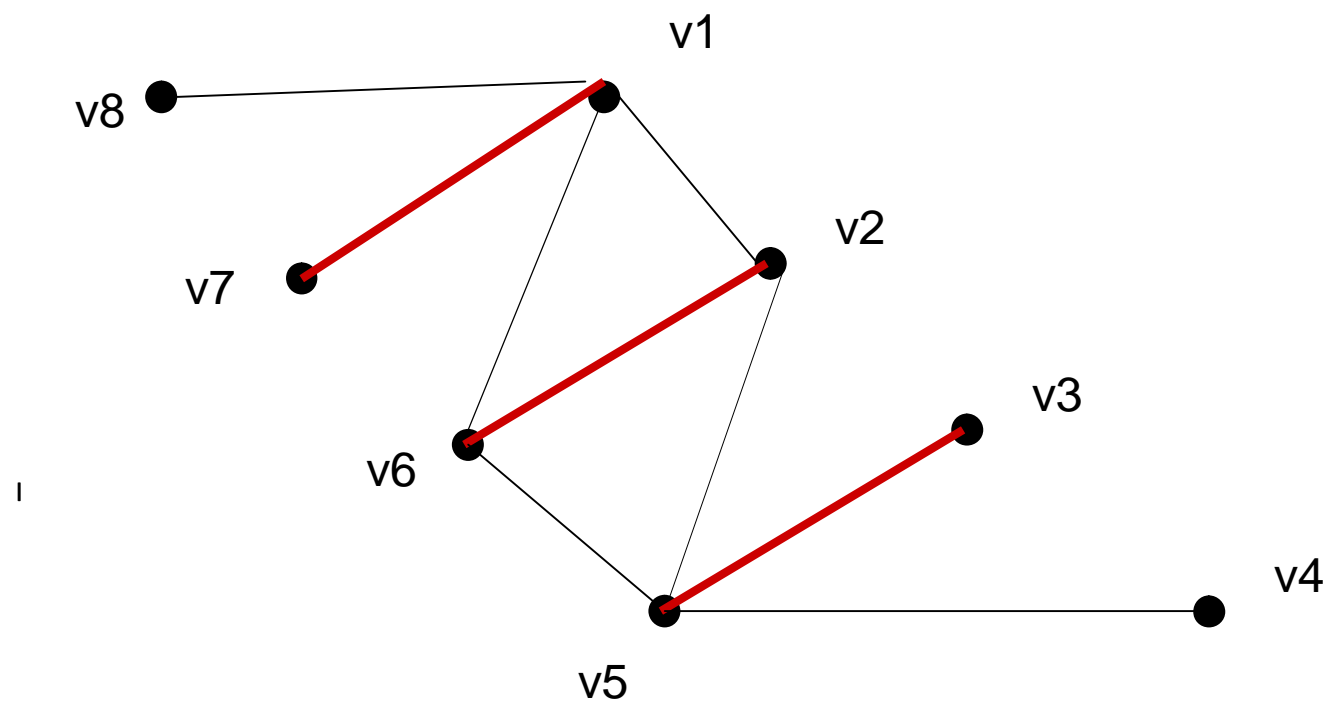

$\Leftrightarrow 3$

\Leftrightarrow

3

4 (4) ; ; ;

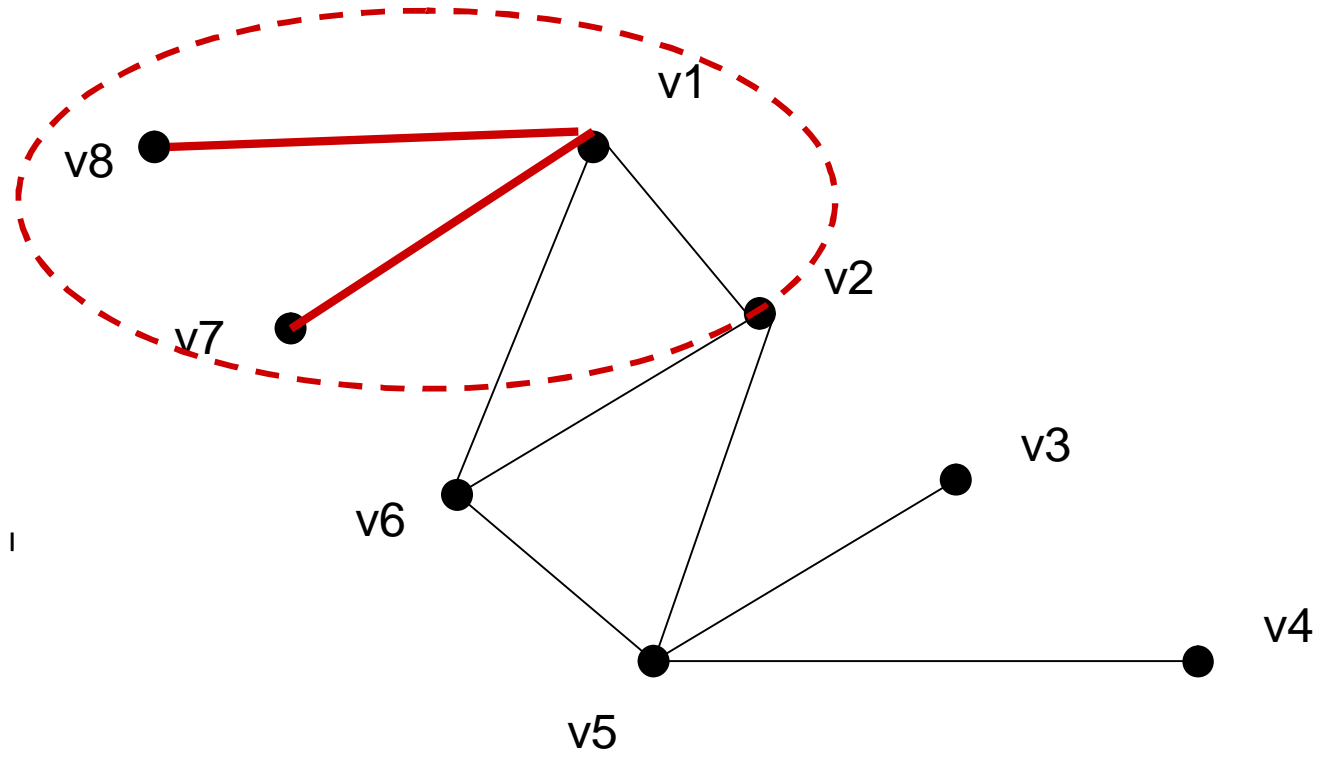

l

v6

v5

3

45

v3

v4

!

(perfect matching)

”

(perfect matching)

|

”

” \Leftrightarrow

”

$|V|/2 \Rightarrow$

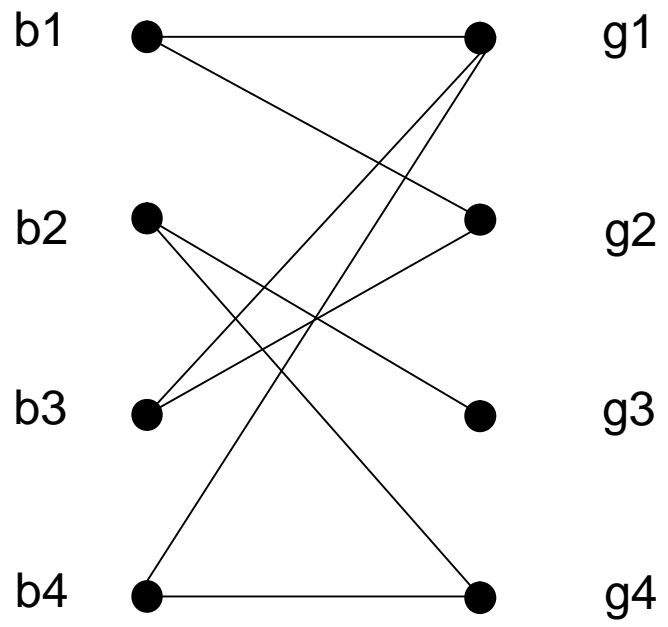

1

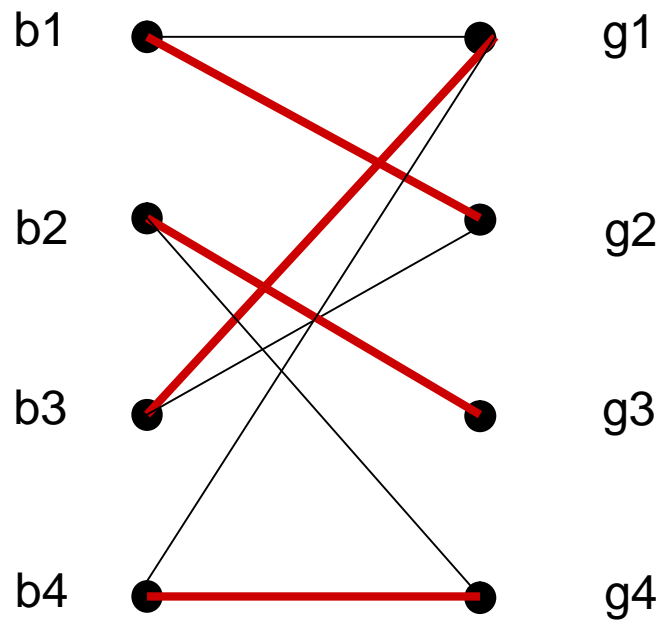

l

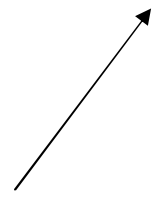
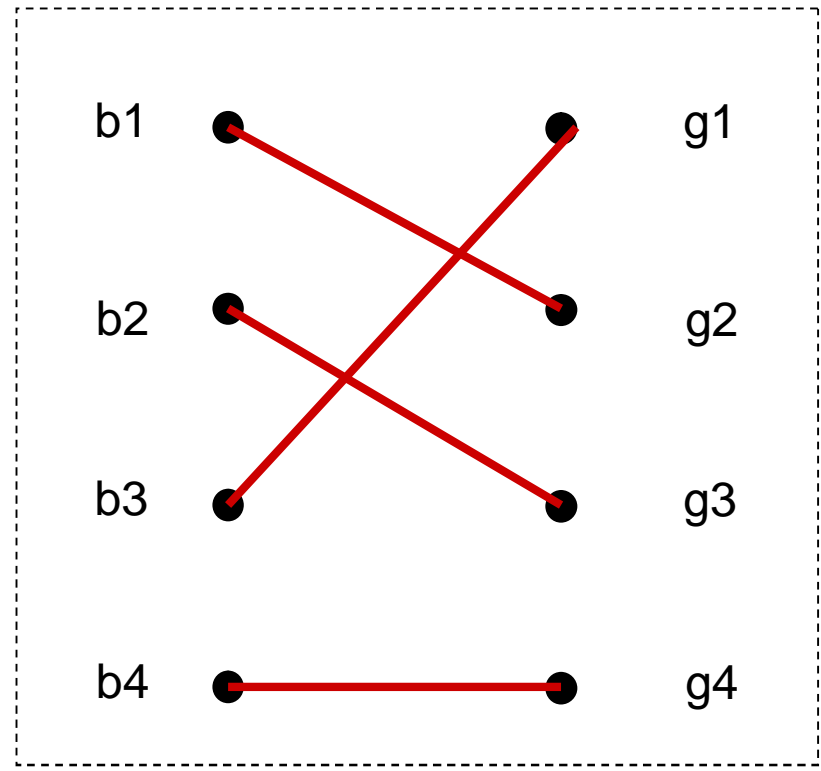
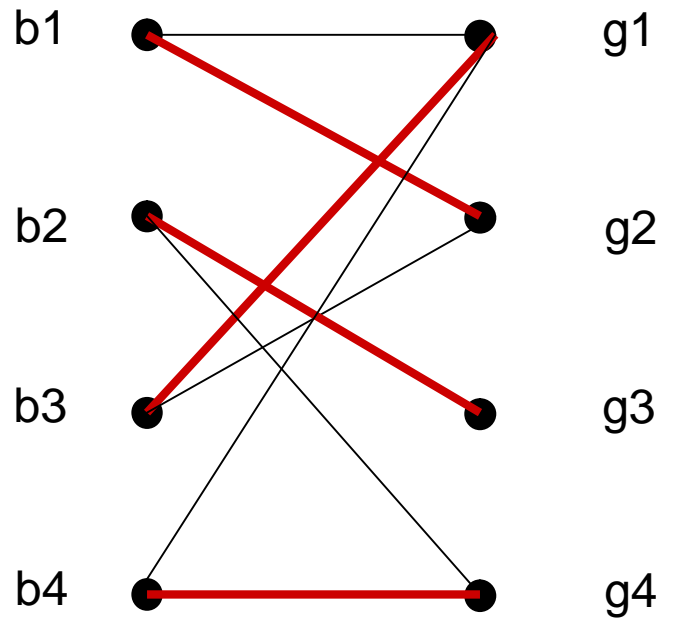

!!

()

“

,

“

⇒

|

“

⇒

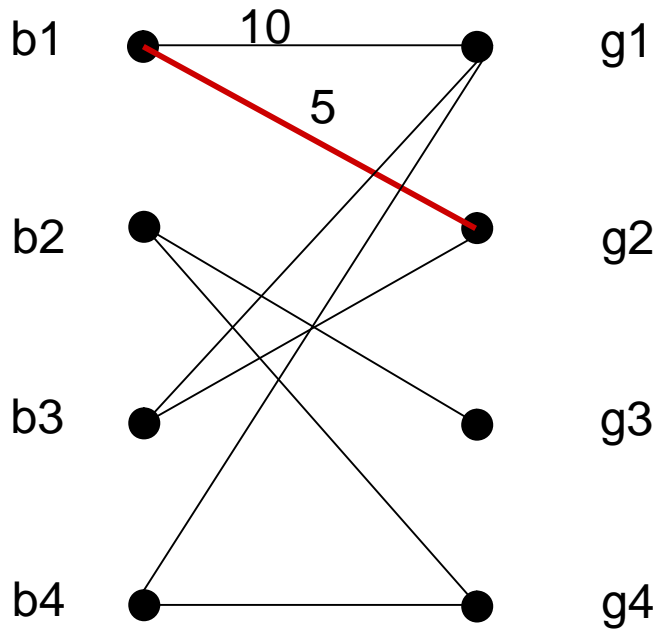

⇔

()

“

,

“

⇒

|

“

⇒

“

:

“

, :

M

”

|

.

,

”

,

0



“

:

”

, G,

I

G

“

”

|

:

G

, G,

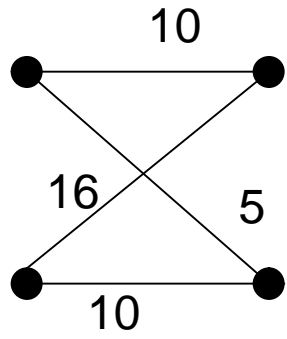

;

“

”

|

:

G

, G,

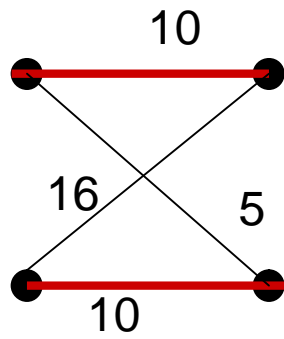

20

;

\tilde{O} ;

“

.

“

|

“

2

“

(NP-complete)

“

l “

,

.

.

.

(, %o +)

q

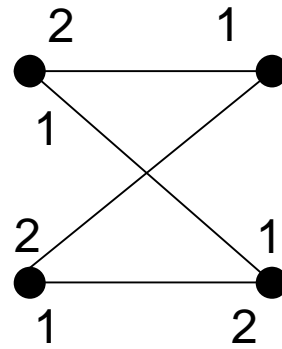
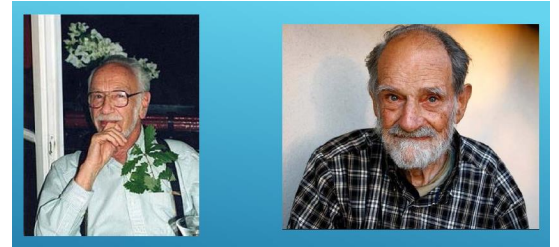

;

1

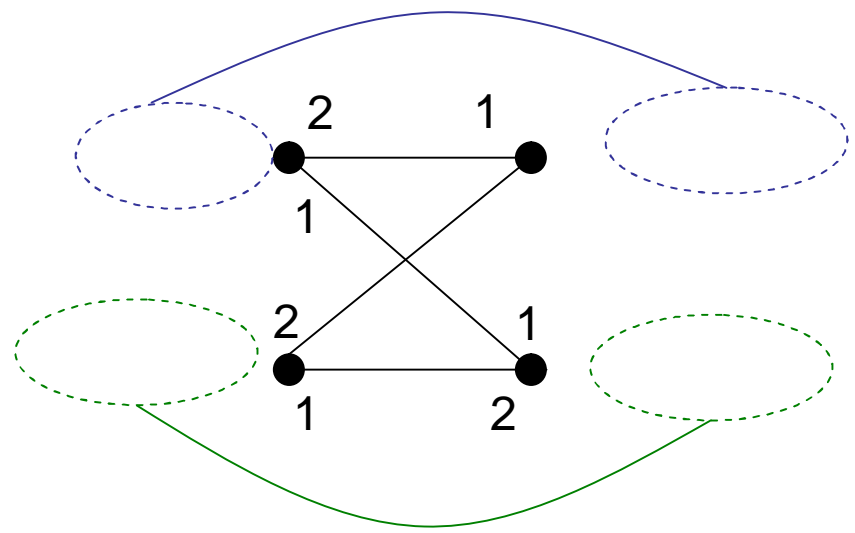

;

$\tilde{0}$

l

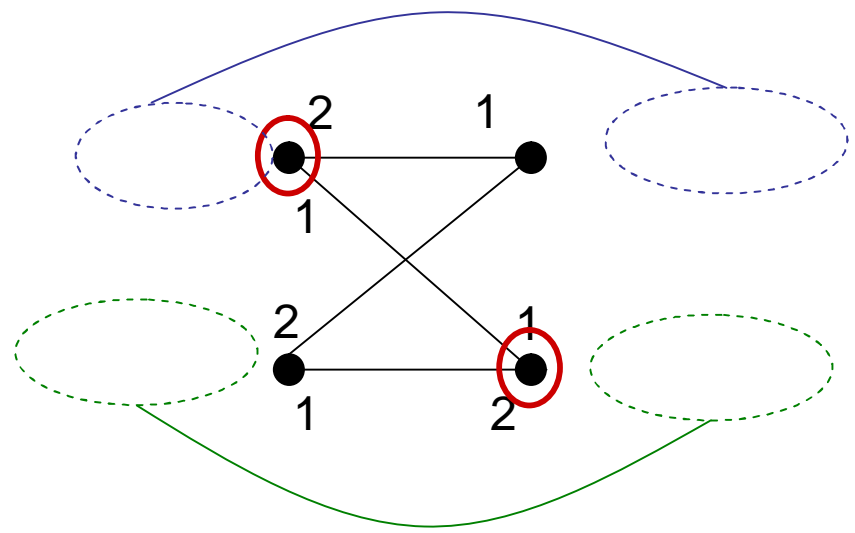

;

$\tilde{0}$

l

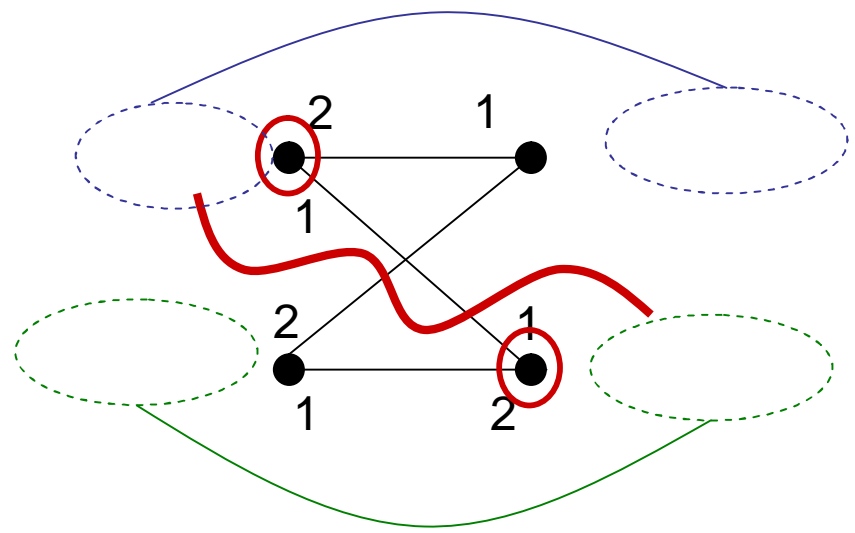

\Rightarrow

«

» (rogue couple)

«

»

(rogue couples)

”

(matching) ,

x
» (rogue

y,
couple)

«

|

”

«

»

”

.
⇒
«

»

(stable)

«

»

(rogue couples)

”

«

»

”

:

.

;

.

”

:

”

!

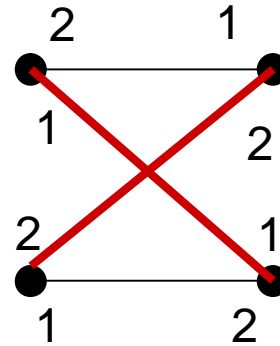

▪
;

;

“

”

,

;

| “

○

▪ ▪ ,

”

«

»

▪

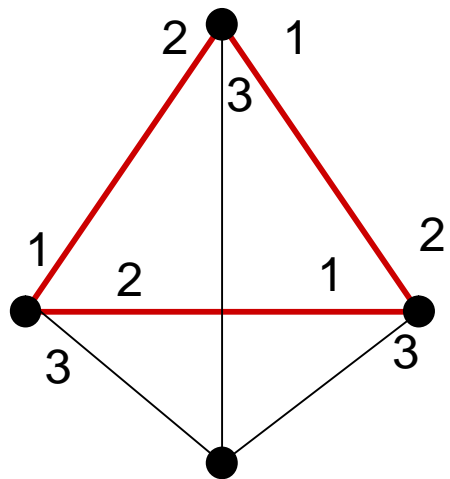

1

“

“ ()

· ,
· « »
· ,

“ $W \log ()$

|

·
⇒ ,
“ «
“ ⇒ !!

»;

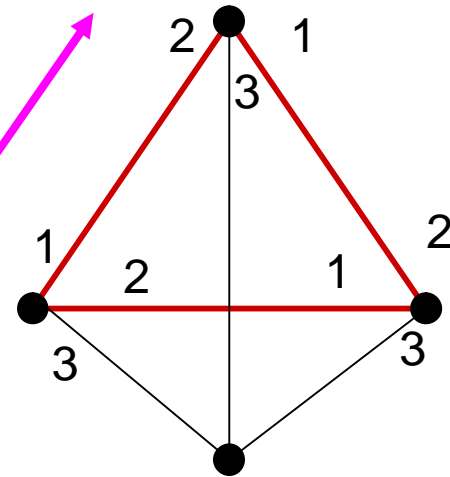

▪
;

;

“

“

,

;

|

“

○

▪ ▪ ▪,

“

«

»

▪

(The Stable Marriage Problem . SMP)

“ N N

.

“

. ,

.

“

“

“

“

:

«

»

(The Stable Marriage Problem . SMP)

1: C, B, E, A, D

2: A, B, E, C, D

3: D, C, B, A, E

4: A, C, D, B, E

5: A, B, D, E, C

A: 3, 5, 2, 1, 4

B: 5, 2, 1, 4, 3

C: 4, 3, 5, 1, 2

D: 1, 2, 3, 4, 5

E: 2, 3, 4, 1, 5

::

(The Stable Marriage Problem . SMP)

1: C, B, E, A, D

2: A, B, E, C, D

3: D, C, B, A, E

4: A, C, D, B, E

5: A, B, D, E, C

A: 3, 5, 2, 1, 4

B: 5, 2, 1, 4, 3

C: 4, 3, 5, 1, 2

D: 1, 2, 3, 4, 5

E: 2, 3, 4, 1, 5

:

(greedy algorithm)

(The Stable Marriage Problem . SMP)

1: **C**, B, E, A, D

2: **A**, B, E, C, D

3: **D**, C, B, A, E

4: ~~A, C, D~~, **B**, E

5: ~~A, B, D~~, **E**, C

A: 3, 5, 2, 1, 4

B: 5, 2, 1, 4, 3

C: 4, 3, 5, 1, 2

D: 1, 2, 3, 4, 5

E: 2, 3, 4, 1, 5

:

(greedy algorithm)

(The Stable Marriage Problem . SMP)

1: **C**, B, E, A, D

2: **A**, B, E, C, D

3: **D**, C, B, A, E

4: ~~A, C, D~~, **B**, E

5: ~~A, B, D~~, **E**, C

A: 3, 5, 2, 1, 4

B: 5, 2, 1, 4, 3

C: 4, 3, 5, 1, 2

D: 1, 2, 3, 4, 5

E: 2, 3, 4, 1, 5

:

(greedy algorithm)

(The Stable Marriage Problem . SMP)

1: **C**, B, E, A, D

2: **A**, B, E, C, D

3: **D**, C, B, A, E

4: ~~A, C, D~~, **B**, E

5: ~~A, B, D~~, **E**, C

A: 3, 5, 2, 1, 4

B: 5, 2, 1, 4, 3

C: 4, 3, 5, 1, 2

D: 1, 2, 3, 4, 5

E: 2, 3, 4, 1, 5



:

(greedy algorithm)

«

» $\tilde{0}$

\Rightarrow

(The Stable Marriage Problem . SMP)

1: C, B, E, A, D

2: A, B, E, C, D

3: D, C, B, A, E

4: A, C, D, B, E

5: A, B, D, E, C

:

3

:

“

“

“

A: 3, 5, 2, 1, 4

B: 5, 2, 1, 4, 3

C: 4, 3, 5, 1, 2

D: 1, 2, 3, 4, 5

E: 2, 3, 4, 1, 5

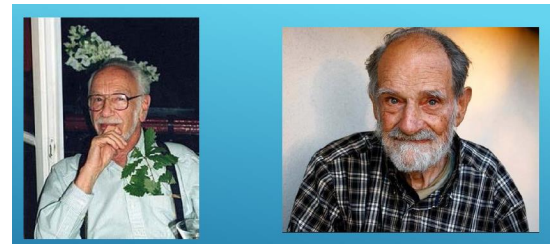

(The Stable Marriage Problem . SMP)

1: C, B, E, A, D

A: 3, 5, 2, 1, 4

2: A, B, E, C, D

B: 5, 2, 1, 4, 3

3: D, C, B, A, E

C: 4, 3, 5, 1, 2

4: A, C, D, B, E

D: 1, 2, 3, 4, 5

5: A, B, D, E, C

E: 2, 3, 4, 1, 5

:

3

:

:

(The Stable Marriage Problem . SMP)

1: C, B, E, A, D

A: 3, 5, 2, 1, 4

2: A, B, E, C, D

B: 5, 2, 1, 4, 3

3: D, C, B, A, E

C: 4, 3, 5, 1, 2

4: A, C, D, B, E

D: 1, 2, 3, 4, 5

5: A, B, D, E, C

E: 2, 3, 4, 1, 5

:

3

:

1

,

«

»

,

«

»

(The Stable Marriage Problem . SMP)

1: C, B, E, A, D

A: 3, 5, 2, 1, 4

2: A, B, E, C, D

B: 5, 2, 1, 4, 3

3: D, C, B, A, E

C: 4, 3, 5, 1, 2

4: A, C, D, B, E

D: 1, 2, 3, 4, 5

5: A, B, D, E, C

E: 2, 3, 4, 1, 5

:

3

:

”

(The Stable Marriage Problem . SMP)

1: C, B, E, A, D

2: A, B, E, C, D

3: D, C, B, A, E

4: A, C, D, B, E

5: A, B, D, E, C

A: 3, 5, 2, 1, 4

B: 5, 2, 1, 4, 3

C: 4, 3, 5, 1, 2

D: 1, 2, 3, 4, 5

E: 2, 3, 4, 1, 5

1
« , »!

:

:

2

(The Stable Marriage Problem . SMP)

1: C, B, E, A, D	2,4,5	A: 3, 5, 2, 1, 4
2: A, B, E, C, D	--	B: 5, 2, 1, 4, 3
3: D, C, B, A, E	1	C: 4, 3, 5, 1, 2
4: A, C, D, B, E	3	D: 1, 2, 3, 4, 5
5: A, B, D, E, C	--	E: 2, 3, 4, 1, 5

(The Stable Marriage Problem . SMP)

1: C, B, E, A, D	2,4, 5	A: 3, 5, 2, 1, 4
2: A, B, E, C, D	--	B: 5, 2, 1, 4, 3
3: D, C, B, A, E	1	C: 4, 3, 5, 1, 2
4: A, C, D, B, E	3	D: 1, 2, 3, 4, 5
5: A, B, D, E, C	--	E: 2, 3, 4, 1, 5

(The Stable Marriage Problem . SMP)

1: C, B, E, A, D	2,4, 5	A: 3, 5, 2, 1, 4
2: A , B, E, C, D	--	B: 5, 2, 1, 4, 3
3: D, C, B, A, E	1	C: 4, 3, 5, 1, 2
4: A , C, D, B, E	3	D: 1, 2, 3, 4, 5
5: A, B, D, E, C	--	E: 2, 3, 4, 1, 5

(The Stable Marriage Problem . SMP)

1: C, B, E, A, D

5

A: 3, 5, 2, 1, 4

2: B, E, C, D

2

B: 5, 2, 1, 4, 3

3: D, C, B, A, E

1,4

C: 4, 3, 5, 1, 2

4: C, D, B, E

3

D: 1, 2, 3, 4, 5

5: A, B, D, E, C

--

E: 2, 3, 4, 1, 5

(The Stable Marriage Problem . SMP)

1: C, B, E, A, D

5

A: 3, 5, 2, 1, 4

2: B, E, C, D

2

B: 5, 2, 1, 4, 3

3: D, C, B, A, E

1,4

C: 4, 3, 5, 1, 2

4: C, D, B, E

3

D: 1, 2, 3, 4, 5

5: A, B, D, E, C

--

E: 2, 3, 4, 1, 5

(The Stable Marriage Problem . SMP)

1: **C**, B, E, A, D

5

A: 3, 5, 2, 1, 4

2: B, E, C, D

2

B: 5, 2, 1, 4, 3

3: D, C, B, A, E

1, **4**

C: 4, 3, 5, 1, 2

4: C, D, B, E

3

D: 1, 2, 3, 4, 5

5: A, B, D, E, C

--

E: 2, 3, 4, 1, 5

(The Stable Marriage Problem . SMP)

1: B, E, A, D

5

A: 3, 5, 2, 1, 4

2: B, E, C, D

1,2

B: 5, 2, 1, 4, 3

3: D, C, B, A, E

4

C: 4, 3, 5, 1, 2

4: C, D, B, E

3

D: 1, 2, 3, 4, 5

5: A, B, D, E, C

--

E: 2, 3, 4, 1, 5

(The Stable Marriage Problem . SMP)

1: B, E, A, D

5

A: 3, 5, 2, 1, 4

2: B, E, C, D

1,2

B: 5, 2, 1, 4, 3

3: D, C, B, A, E

4

C: 4, 3, 5, 1, 2

4: C, D, B, E

3

D: 1, 2, 3, 4, 5

5: A, B, D, E, C

--

E: 2, 3, 4, 1, 5

(The Stable Marriage Problem . SMP)

1: **B**, E, A, D

5

A: 3, 5, 2, 1, 4

2: B, E, C, D

1, **2**

B: 5, 2, 1, 4, 3

3: D, C, B, A, E

4

C: 4, 3, 5, 1, 2

4: C, D, B, E

3

D: 1, 2, 3, 4, 5

5: A, B, D, E, C

--

E: 2, 3, 4, 1, 5

(The Stable Marriage Problem . SMP)

1: E, A, D

5

A: 3, 5, 2, 1, 4

2: B, E, C, D

2

B: 5, 2, 1, 4, 3

3: D, C, B, A, E

4

C: 4, 3, 5, 1, 2

4: C, D, B, E

3

D: 1, 2, 3, 4, 5

5: A, B, D, E, C

1

E: 2, 3, 4, 1, 5

4

1

(The Stable Marriage Problem . SMP)

1: E, A, D

5

A: 3, 5, 2, 1, 4

2: B, E, C, D

2

B: 5, 2, 1, 4, 3

3: D, C, B, A, E

4

C: 4, 3, 5, 1, 2

4: C, D, B, E

3

D: 1, 2, 3, 4, 5

5: A, B, D, E, C

1

E: 2, 3, 4, 1, 5

«

»;

!!

⇒

!!

1: C, B, E, A, D

2: A, B, E, C, D

3: D, C, B, A, E

4: A, C, D, B, E

5: A, B, D, E, C

(The Stable Marriage Problem . SMP)

“

:

|

·

”

·

«

»

·

:

·

;

(The Stable Marriage Problem . SMP)

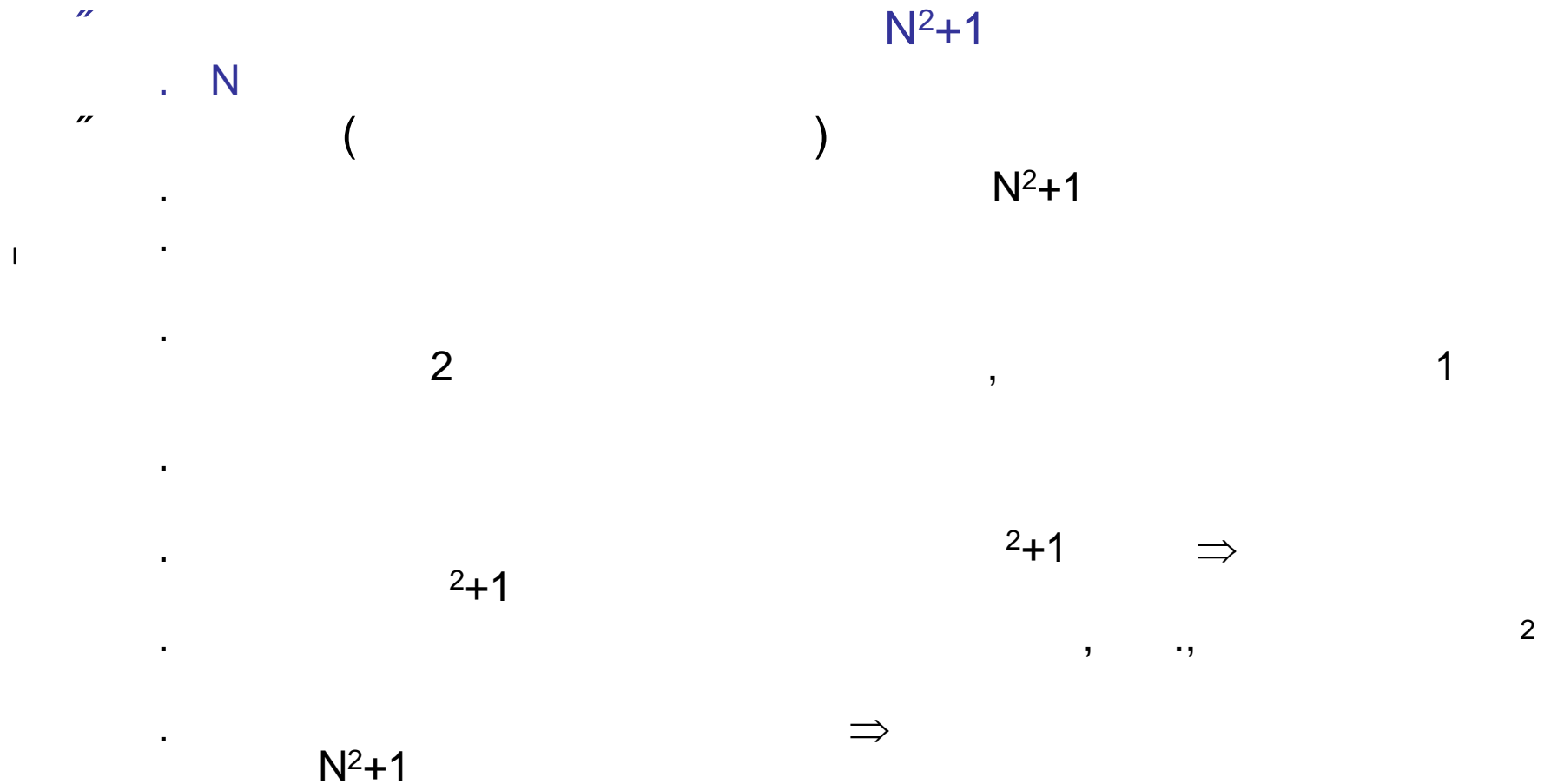

(The Stable Marriage Problem . SMP)

”

,

”

”

|

,

”

,

«

»

”

:

.

,

.

,

(The Stable Marriage Problem . SMP)

" P: , G, , B, , G,
, B

" () q

" () 0;

" () P

" () P d+1;

» HG B d+1 ;; !!

» HG P B d+1
d ⇒ HG d+1, P
d+1 B d

(The Stable Marriage Problem . SMP)

“

“ (, B,)

· “ , B,

“

·

“ ;

“

,

“ ⇒

“ ⇒

“

,

(The Stable Marriage Problem . SMP)

“ : ;

”

.

\tilde{o}

”

|

\tilde{o}

\tilde{o}

”

.

,

:

;

”

.

;

(The Stable Marriage Problem . SMP)

" , S

" $S \neq \emptyset$;

l . \Rightarrow S q

" P (realm of possibility)

$$\{Q \mid \exists M \in S \{P, Q\} \in M\}$$

$\Rightarrow 0$

« »

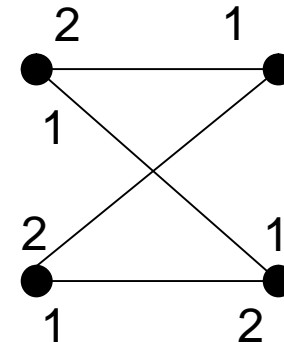

(The Stable Marriage Problem . SMP)

”

(optimal mate):

.

”

(pessimal mate):

|

”

.

(optimal mate)

.

(pessimal mate)

”

:

.

.

(The Stable Marriage Problem . SMP)

”

(optimal

mate)

”

(pessimal mate)

.

q

To
 $G(B, G; \dots)$
 \Rightarrow « »
 \Rightarrow !!

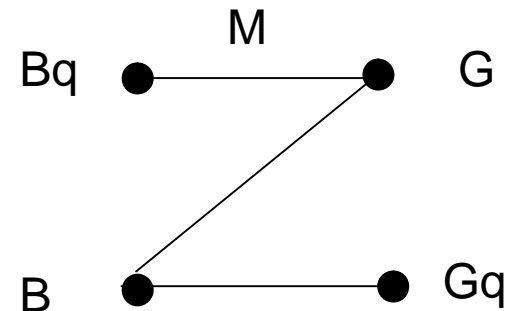

(The Stable Marriage Problem . SMP)

“ :

!!

“

|

.

“

«

»;

õ !!!!!

. Online dating

(load balancing)

Web

.

“

web servers

“

servers

(The Stable Marriage Problem . SMP)

“

:

.

group
visibility

|

.

groups

.

groups

.

∴